



# GMS305P-1/4"

## Technical Data

- PTFE Construction
- 1/4" NPT / 1/4" NPT Drain
- 100 PSIG Maximum Pressure
- Internal Volume: 5.0cc (Upstream), 35.0cc (Downstream)
- Viton O-Ring (Standard-Included)
- Total Weight: 7.0 lbs.
- Flow Rate: 3 LPM (M1 - Low Flow Membrane), 43 LPM (M2- High Flow Membrane)

### Elements Available:

MT.89.MxH

Replacement Membrane Kit  
Comes Complete with Five Membranes with Viton O-Rings,  
Membrane Options: M1 (Low Flow) or M2 (High Flow)  
Replace 'Mx' with membrane required

### Available O-Rings:

<b>GVGMS305</b>	<b>Viton (Set of 2) (-15°F to 400°F) <b>**Standard - Included**</b></b>
BNGMS305	Buna-N (Set of 2) (-40°F to 250°F)
KZGMS305	Perfluoroelastomer (Set of 2) (5°F to 600°F)
GSGMS305	Silicone (Set of 2) (-65°F to 400°F)
GEGMS305	EPDM (Set of 2) (-65°F to 300°F)

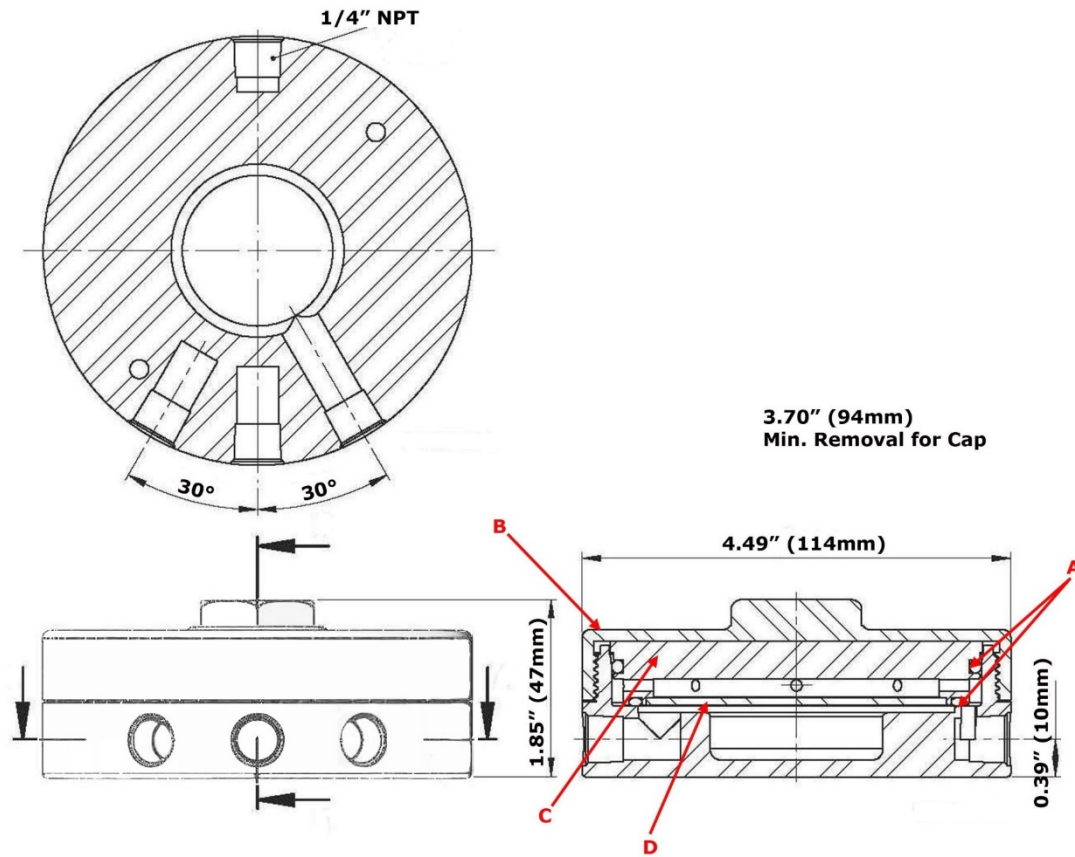

### Replacement Parts:

<b>GVGMS305</b>	<b>Viton (Set of 2) (-15°F to 400°F) (A) <b>**Standard - Included**</b></b>
GMS305P-C	PTFE Cap (B)
GMS305P-Plug	PTFE Plug Insert (C)
GMS305PT-Disc	PTFE Support Disc (D)

### Accessories:

MBGMS305	Stainless Steel Mounting Bracket (M6 x 14 Full Thread on 3.50" Center @ 45° to Port)
----------	---