



Technical Data

- Nylon Construction
- 1/4" NPT / Manual Twist Drain
- 100 PSIG Maximum Pressure
- Internal Volume (with Tie Rod / No Element): 52CC
- Viton O-Ring (Standard-Included)
- Total Weight: 0.5 lbs.
- Flow Rate @ 100 PSIG: 27 SCFM (Maximum Recommended Flow Rate for Optimal Efficiency)
 - Based on 12-57-70C Standard Coalescing Grade Element, 95% Efficient at 0.01 Micron
 - Higher flow rates are supported with increased initial pressure drop

Elements Available:

12-57-**xxx**

Disposable Borosilicate Glass Microfiber Filter Element

12-57-70C – Standard Coalescing Filter Element

SS-12-57-**xxT**

Stainless Steel Filter Element

Comes Standard with Teflon Seals "T", Add "V" for optional Viton Seals when Ordering
Micron Sizes: 005, 01, 03, 10, 25, 50, 100 and 200

PT-12-57-**xx**

PTFE Filter Element

Micron Sizes: 03 and 25

PEL-12-57-**xx**

PEL (Polyethylene) Filter Element

Micron Sizes: 10, 25, and 75

Replace "**xxx**" with grade or micron needed. See [Filter Element Guide](#) for more information.

Available O-Rings:

GV710

Viton (-15°F to 400°F) **Standard - Included******

BN710

Buna-N (-40°F to 250°F)

KZ710

Perfluoroelastomer (5°F to 600°F)

GS710

Silicone (-65°F to 400°F)

GE710

EPDM (-65°F to 300°F)

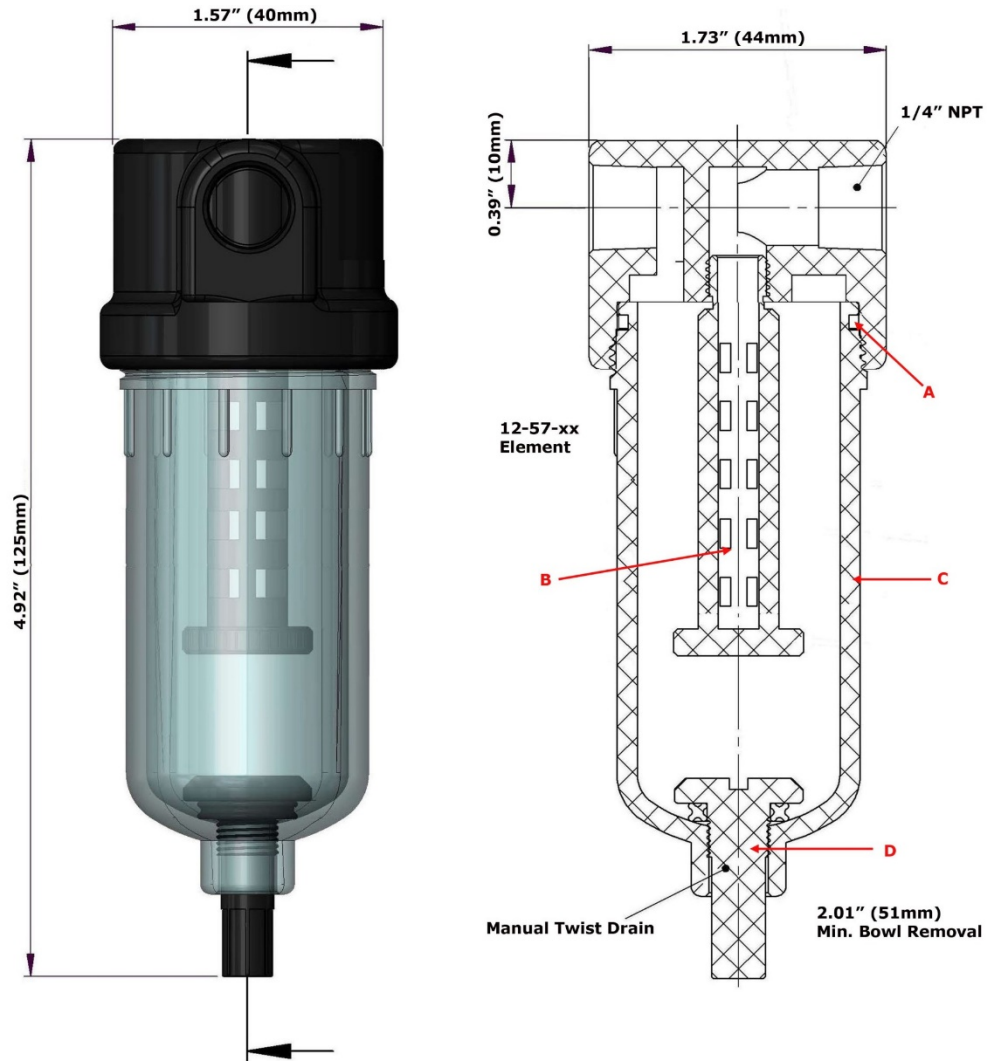

Replacement Parts:

GV710	Viton (-15°F to 400°F) (A) **Standard - Included**
TR315L	Nylon Element Retainer (B)
NB730	Nylon Bowl (C)
DV360	Nylon Manual Twist Drain (D)

Accessories:

MBSS315	Stainless Steel Mounting Bracket (M5 x 10 Full Thread on 1.00" Center @ 90° to Port)
---------	---