



Technical Data

- Anodized Aluminum Construction
- 1/4" NPT / No Drain
- 250 PSIG Maximum Pressure
- Internal Volume (with Tie Rod / No Element): 50CC
- Buna-N O-Ring (Standard-Included)
- Total Weight: 1 lb. (Standard Disposable Element Included)
- Flow Rate @ 100 PSIG: 23 SCFM (Maximum Recommended Flow Rate for Optimal Efficiency)
 - Based on 12-32-70C Standard Coalescing Grade Element, 95% Efficient at 0.01 Micron
 - Higher flow rates are supported with increased initial pressure drop

Elements Available:

12-32-**xxx**

Disposable Borosilicate Glass Microfiber Filter Element

12-32-70C – Standard Coalescing Filter Element ****Included****

SS-12-32-**xxT**

Stainless Steel Filter Element

Comes Standard with Teflon Seals "T", Add "V" for optional Viton Seals when Ordering
Micron Sizes: 005, 01, 03, 10, 25, 50, 100 and 200

12-48-**10**PLCL

Pleated Cellulose Filter Element

Micron Size: 10

PT-12-32-**xx**

PTFE Filter Element

Micron Sizes: 03 and 25

PEL-12-32-**xx**

PEL (Polyethylene) Filter Element

Micron Sizes: 10, 25, and 75

TRE12-32-**xx**

Adsorption Cartridge

Adsorbents: CC, 4A, 13X, SG, DR, MB, PP, HO, SB, and CS

Replace "**xxx**" with grade, micron, or adsorbent needed. See [Filter Element Guide](#) for more information.

Available O-Rings:

BN315

Buna-N (-40°F to 250°F) **Standard - Included******

GV315

Viton (-15°F to 400°F)

KZ315

Perfluoroelastomer (5°F to 600°F)

GS315

Silicone (-65°F to 400°F)

GE315

EPDM (-65°F to 300°F)

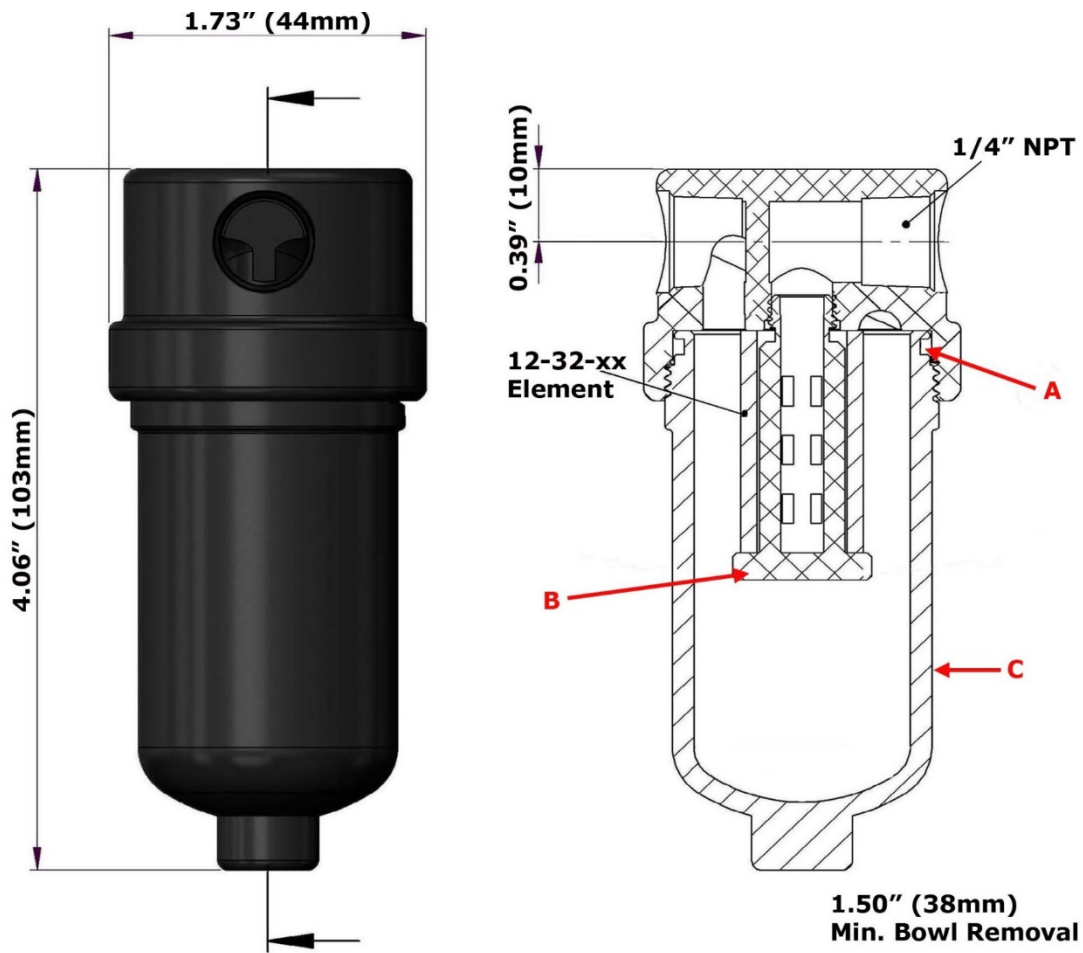

Replacement Parts:

BN315	Buna-N (-40°F to 250°F) (A) **Standard - Included**
TR315	Nylon Element Retainer (B)
AB305	Anodized Aluminum Bowl (C)

Accessories:

MBSS315	Stainless Steel Mounting Bracket (M5 x 10 Full Thread on 1.00" Center @ 90° to Port)
---------	---

