



# Model 146VP

## Technical Data

- 316L Stainless Steel Construction
- 1/2" NPT / No Drain
- 6000 PSIG Maximum Pressure
- Internal Volume (with Tie Rod / No Element): 270cc
- Viton O-Ring (Standard-Included)
- Total Weight: 15 lbs.
- Flow Rate @ 100 PSIG: 129 SCFM (Maximum Recommended Flow Rate for Optimal Efficiency)
  - Based on 25-178-70C Standard Coalescing Grade Element, 95% Efficient at 0.01 Micron
  - Higher flow rates are supported with increased initial pressure drop

### Elements Available:

25-178-xxx

**Disposable Borosilicate Glass Microfiber Filter Element**  
25-178-70C – Standard Recommended Coalescing Filter Element

SS-25-178-xxT

**Stainless Steel Filter Element**  
Comes Standard with Teflon Seals "T", Add "V" for optional Viton Seals when Ordering  
Micron Sizes: 005, 01, 03, 10, 25, 50, 100 and 200

25-178-xxxX1

**Reinforced Borosilicate Glass Microfiber Filter Element**  
With Exterior Stainless Steel Cage

25-178-xxxX3

**Reinforced Borosilicate Glass Microfiber Filter Element**  
With Interior & Exterior Stainless Steel Cages

PT-25-178-xx

**PTFE Filter Element**  
Micron Sizes: 03 and 25

PEL-25-178-xx

**PEL (Polyethylene) Filter Element**  
Micron Sizes: 10, 25, and 75

25-178-xx-TS

**Adsorption Cartridge**  
Adsorbents: CC, 4A, 13X, SG, DR, MB, PP, HO, SB, and CS

Replace "xxx" with grade, micron, or adsorbent needed. See [Filter Element Guide](#) for more information.

### Available O-Rings:

GV130VP

**Viton (-15°F to 400°F) **\*\*Standard - Included\*\*****

BN130VP

Buna-N (-40°F to 250°F)

KZ130VP

Perfluoroelastomer (5°F to 600°F)

GS130VP

Silicone (-65°F to 400°F)

GE130VP

EPDM (-65°F to 300°F)

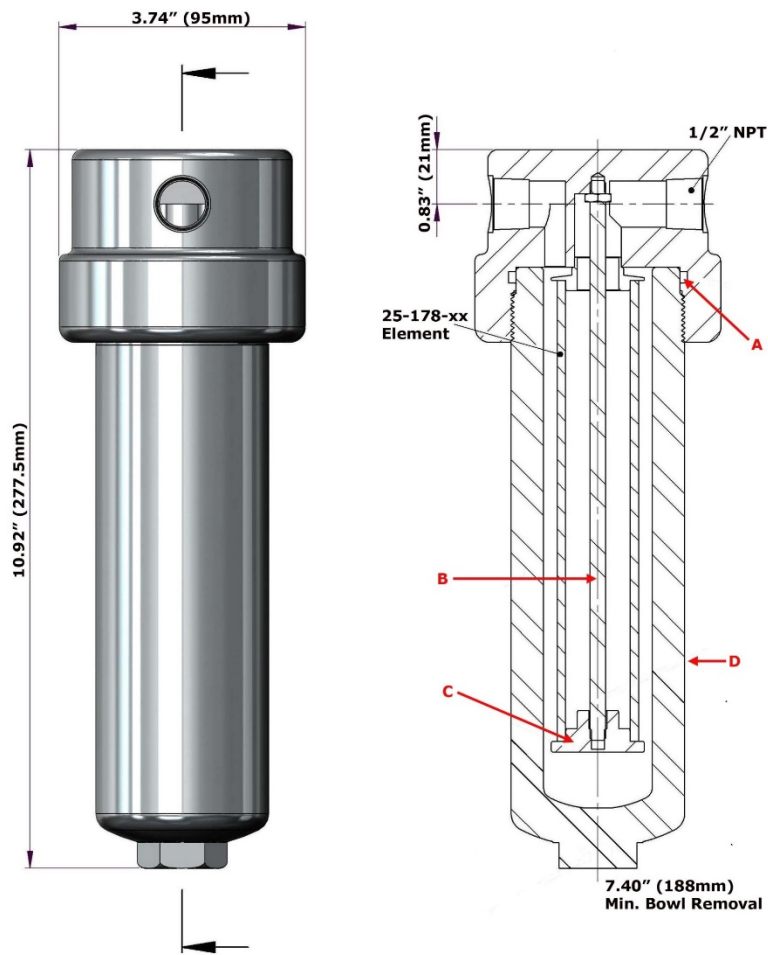

### Replacement Parts:

GV130VP	Viton (-15°F to 400°F) (A) <b>**Standard - Included**</b>
TR140VP	Stainless Steel Tie Rod (B)
ER130VP	Stainless Steel Element Retainer (C)
SSB144VP	Stainless Steel Bowl (D)

### Accessories:

SC140	Stainless Steel Support Core
MBSS150	Stainless Steel Mounting Bracket (M10 x 15 Full Thread on 2.50" Center @ 90° to Port)

### Part Number of Exotic Housing Materials:

Monel A400:	<a href="#">Model 146VPM (Drawing)</a>
Hastelloy C-276:	<a href="#">Model 146VP-HC (Drawing)</a>
Inconel A625:	<a href="#">Model 146VP-INC (Drawing)</a>