



Technical Data

- PTFE Construction
- 1/2" NPT / 1/4" NPT Drain
- 100 PSIG Maximum Pressure
- Internal Volume (with Tie Rod / No Element): 260cc
- Viton O-Ring (Standard-Included)
- Total Weight: 3 lbs.
- Flow Rate @ 100 PSIG: 129 SCFM (Maximum Recommended Flow Rate for Optimal Efficiency)
 - Based on 25-178-70C Standard Coalescing Grade Element, 95% Efficient at 0.01 Micron
 - Higher flow rates are supported with increased initial pressure drop

Elements Available:

25-178-**xxx**

Disposable Borosilicate Glass Microfiber Filter Element

25-178-70C – Standard Recommended Coalescing Filter Element

SS-25-178-**xxT**

Stainless Steel Filter Element

Comes Standard with Teflon Seals "T", Add "V" for optional Viton Seals when Ordering
Micron Sizes: 005, 01, 03, 10, 25, 50, 100 and 200

PT-25-178-**xx**

PTFE Filter Element

Micron Sizes: 03 and 25

PEL-25-178-**xx**

PEL (Polyethylene) Filter Element

Micron Sizes: 10, 25, and 75

Replace "**xxx**" with grade or micron needed. See [Filter Element Guide](#) for more information.

Available O-Rings:

GV130P

Viton (-15°F to 400°F) **Standard - Included******

BN130P

Buna-N (-40°F to 250°F)

KZ130P

Perfluoroelastomer (5°F to 600°F)

GS130P

Silicone (-65°F to 400°F)

GE130P

EPDM (-65°F to 300°F)

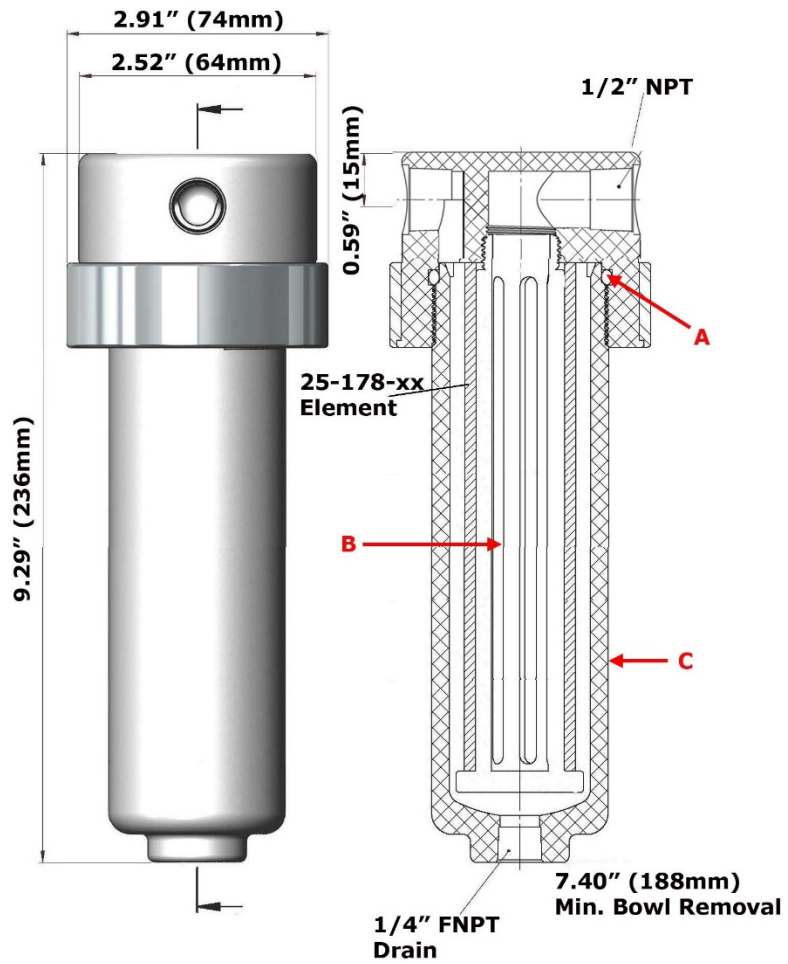

Replacement Parts:

GV130P	Viton (-15°F to 400°F) (A) **Standard - Included**
TR140P	PTFE Tie Rod w/ Element Retainer (B)
GB140P	PTFE Bowl (C)

Accessories:

MBSS140	Stainless Steel Mounting Bracket (M6 x 12 Full Thread on 1.50" Center @ 90° to Port)
---------	---

