



Technical Data

- 316L Stainless Steel Construction
- 1/2" NPT / 1/4" NPT Drain
- 150 PSIG Maximum Pressure
- Internal Volume (with Tie Rod / No Element): 105cc
- Viton O-Ring (Standard-Included)
- Total Weight: 2.5 lbs.
- Flow Rate @ 100 PSIG: 44 SCFM (Maximum Recommended Flow Rate for Optimal Efficiency)
 - Based on 25-64-70C Standard Coalescing Grade Element, 95% Efficient at 0.01 Micron
 - Higher flow rates are supported with increased initial pressure drop

Elements Available:

25-64- xxx	Disposable Borosilicate Glass Microfiber Filter Element 25-64-70C – Standard Recommended Coalescing Filter Element
SS-25-64- xxT	Stainless Steel Filter Element Comes Standard with Teflon Seals "T", Add "V" for optional Viton Seals when Ordering Micron Sizes: 005, 01, 03, 10, 25, 50, 100 and 200
25-64- xxxX1	Reinforced Borosilicate Glass Microfiber Filter Element With Exterior Stainless Steel Cage
25-64- xxxX3	Reinforced Borosilicate Glass Microfiber Filter Element With Interior & Exterior Stainless Steel Cages
PT-25-64- xx	PTFE Filter Element Micron Sizes: 03 and 25
PEL-25-64- xx	PEL (Polyethylene) Filter Element Micron Sizes: 10, 25, and 75

Replace "xxx" with grade or micron needed. See [Filter Element Guide](#) for more information.

Available O-Rings:

GV137	Viton (-15°F to 400°F) **Standard - Included**
BN137	Buna-N (-40°F to 250°F)
KZ137	Perfluoroelastomer (5°F to 600°F)
GS137	Silicone (-65°F to 400°F)
GE137	EPDM (-65°F to 300°F)

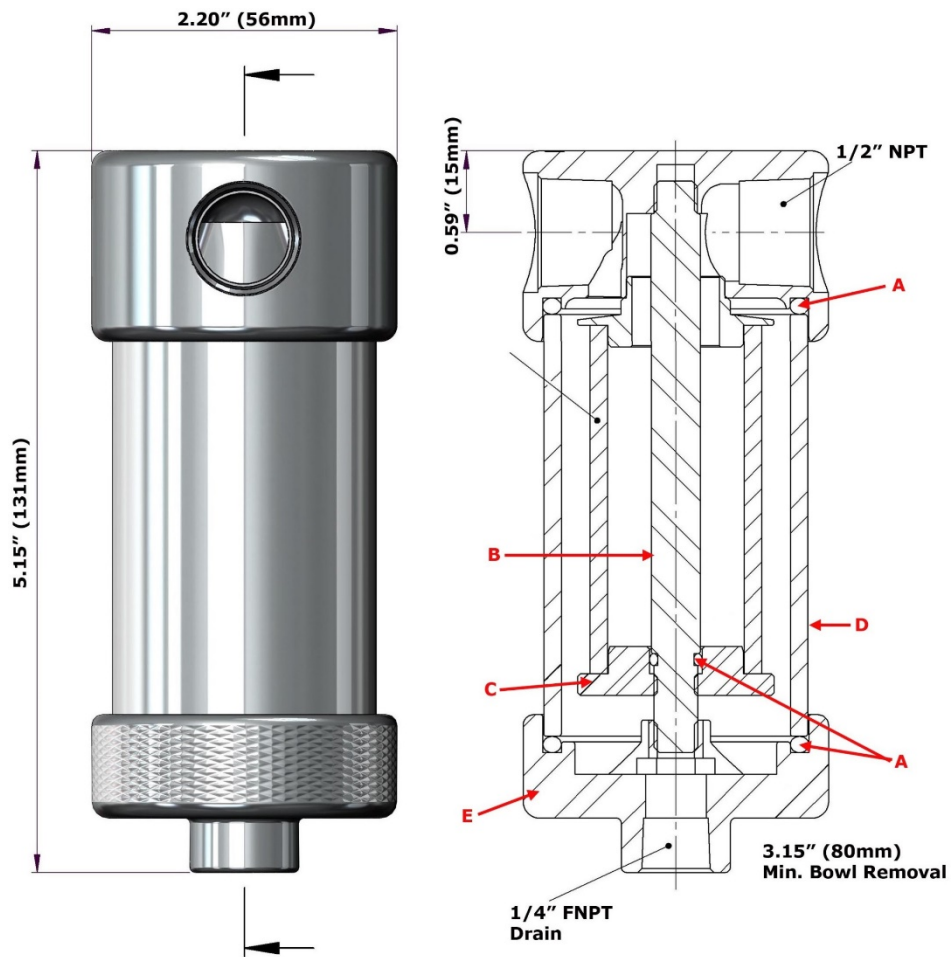

Replacement Parts:

GV137	Viton (-15°F to 400°F) (A) **Standard - Included**
TR137	Stainless Steel Tie Rod (B)
ER137	Stainless Steel Element Retainer (C)
MB137	Stainless Steel Bowl (D)
BP137	Stainless Steel Base Plate (E)

Accessories:

SC130	Stainless Steel Support Core
MBSS130	Stainless Steel Mounting Bracket (M6 x 12 Full Thread on 1.50" Center @ 90° to Port)

Part Number of Exotic Housing Materials:

Monel A400:	Model 138M (Drawing)
Hastelloy C-276:	Model 138HC (Drawing)
Inconel A625:	Model 138-INC (Drawing)