

Model: 132 (1/2" NPT)

Replacement Parts List

25-64-xx	Disposable Filter Element
SS-25-64-xx	Stainless Steel Filter Element Comes Standard with Teflon Seals "T" Add "V" for optional Viton Seals when Ordering
PT-25-64-xx	PTFE Filter Element
PEL-25-64-xx	PEL Filter Element
TR130	Tie Rod (A)
ER130	Element Retainer (B)
SC130	Support Core (Not Pictured)
SSB 130	316L Stainless Steel Bowl (C)
MBSS130	Mounting Bracket (Not Pictured)
Oxygen Cleaning Service Available Note – Please replace "xx" with micron rating or grade	
Available O-Rings	
BN130	Buna-N
GV130	Viton (Standard) (D)
KZ130	Kalrez
GS130	Silicone

For a Solid PTFE Gasket – Order a 132S

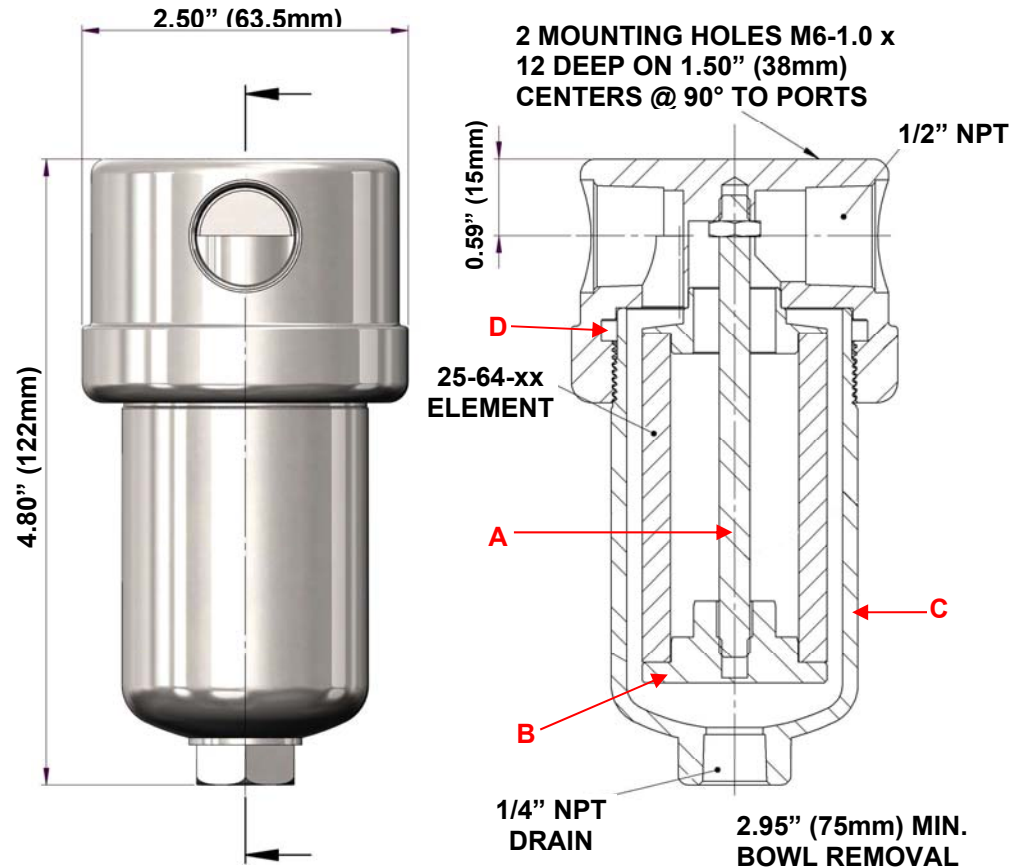

Please Note: Exotic Materials are available, for Hastelloy-C (132HC) and for Monel (132M).

 <p>United Filtration Systems, Inc. 6558 Diplomat Drive Sterling Heights, MI 48314 1-800-311-5561 www.unitedfiltration.com</p>	Model 132		<p>THE COPYRIGHT OF THIS DRAWING IS RESERVED BY UNITED FILTRATION. IT IS ISSUED ON CONDITION THAT IT IS NOT COPIED, REPRODUCED OR DISCLOSED TO A THIRD PART EITHER WHOLLY, OR IN PART WITHOUT CONSENT IN WRITING.</p>
	<p>Material: Head: 316L Stainless Steel Bowl: 316L Stainless Steel Internals: 316L Stainless Steel Standard Gasket / O-ring: Viton</p>	<p>Drain Type: 1/4" FNPT Maximum Temperature: 400°F Maximum Pressure: 1500 PSIG Internal Volume: 110 cc Weight: 2.5 lbs.</p>	
<p>Drawn By & Date UFS0914Y</p>			
<p>DO NOT SCALE DRAWING IF IN DOUBT ASK</p>			