

Model: 126 (1/4" NPT)

Replacement Parts List

12-57-xx	Disposable Filter Element
SS-12-57-xx	Stainless Steel Filter Element Comes Standard with Teflon Seals "T" Add "V" for optional Viton Seals when Ordering
PT-12-57-xx	PTFE Filter Element
PEL-12-57-xx	PEL Filter Element
TR120	Tie Rod (A)
ER110	Element Retainer (B)
SC120	Support Core (Not Pictured)
SSB 120	316L Stainless Steel Bowl (C)
MBSS110	Mounting Bracket (Not Pictured)
Oxygen Cleaning Service Available Note – Please replace "xx" with micron rating or grade	
Available O-Rings	
BN110	Buna-N
GV110	Viton (Standard) (D)
KZ110	Kalrez
GS110	Silicone

For a Solid PTFE Gasket – Order a 126S

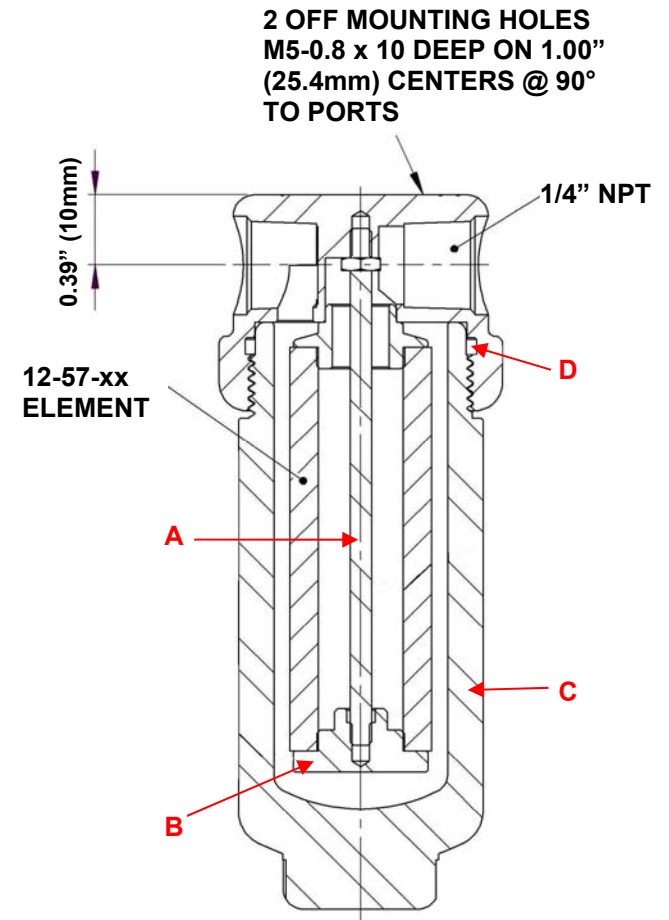

**2.36" (60mm) MIN.
BOWL REMOVAL**

Please Note: Exotic Materials are available, for Hastelloy-C (126HC) and for Monel (126M).

 <p>United Filtration Systems, Inc. 6558 Diplomat Drive Sterling Heights, MI 48314 1-800-311-5561 www.unitedfiltration.com</p> <p>DO NOT SCALE DRAWING IF IN DOUBT ASK</p>	Model 126		<p>THE COPYRIGHT OF THIS DRAWING IS RESERVED BY UNITED FILTRATION. IT IS ISSUED ON CONDITION THAT IT IS NOT COPIED, REPRODUCED OR DISCLOSED TO A THIRD PART EITHER WHOLLY, OR IN PART WITHOUT CONSENT IN WRITING.</p>
	<p>Material: Head: 316L Stainless Steel Bowl: 316L Stainless Steel Internals: 316L Stainless Steel Standard Gasket / O-ring: Viton</p>	<p>Drain Type: None Maximum Temperature: 400°F Maximum Pressure: 5000 PSIG Internal Volume: 30 cc Weight: 1 lb.</p>	